

Connect System to Irrigation Lines

Step 6 - Connect tubing to tank cap by removing the blue and green connector nuts from the bypass fitting by turning them in a counter clockwise direction. (Attach bypass fitting to tubing for later use). Connect the blue connector nut to the water in side of the tank cap. Connect the green connector nut to the fertilizer out connection on the cap. Turn the water on to the system.

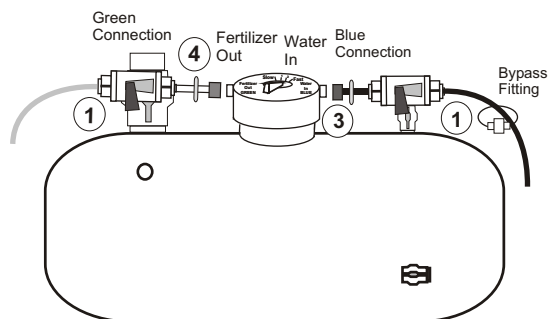

Connect tubing to cap

1. Shut off valves in the off position
2. Turn water on at back flow preventer
3. Connect blue connector to water in connection on cap
4. Connect green connector to fertilizer out connection on cap.

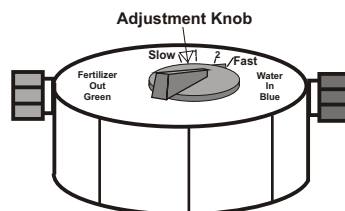

Set Flow Adjustment

Step 8 - Set the flow rate by adjusting the ball valve coupling and the adjustment knob on the tank cap. (The ball valve coupling will only require adjustment at initial startup.)

1. With the cap adjustment setting in the fast position, turn on the sprinkler or drip zone with the lowest gallons per minute flow rate.
2. Slowly close the ball valve very slightly, until you can see fluid movement or color in the clear fertilizer out line.
3. Set the cap adjustment knob to the desired feed rate.
4. Turn off the sprinkler or drip zone.



Fertilize Responsibly™

INSTALLATION AND OPERATING GUIDE BALL VALVE COUPLING CONNECTION

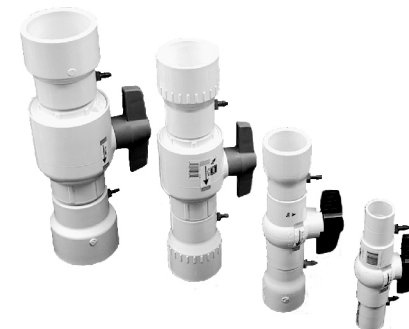

*** IMPORTANT ***
**PLEASE READ INSTRUCTIONS
BEFORE INSTALLING THE SYSTEM.**

Do not connect to an irrigation system that is not protected by an approved back flow prevention device such as a pressure vacuum breaker or reduced pressure zone back flow preventer.

Do not install if pressure exceeds 100 PSI

Follow all local plumbing codes

Use only with non-hazardous products

Minimize exposure to direct sunlight to maximize service life

Protect against impact from foreign objects

All EZ-FLO systems have been specifically designed and engineered to be installed by a professional irrigation or landscape contractor. Improper installation or use could cause risk of water contamination due to back flow or tank rupture. Failure to follow all safety instructions and warnings could result in serious bodily injury. Improper installation or use of the system voids all warranties.

**FOR ASSISTANCE OR FERTILIZER AVAILABILITY
CALL TOLL FREE 1-866-393-5601
OR VISIT OUR WEBSITE AT
www.ezflorfertilizing.com**

System Installation

Typical installation

The system is normally installed in a valve box, connected to the main line of the irrigation system after the back flow preventer and before the sprinkler valves. One unit will feed both drip and sprinkler zones that are downstream from the connection point.

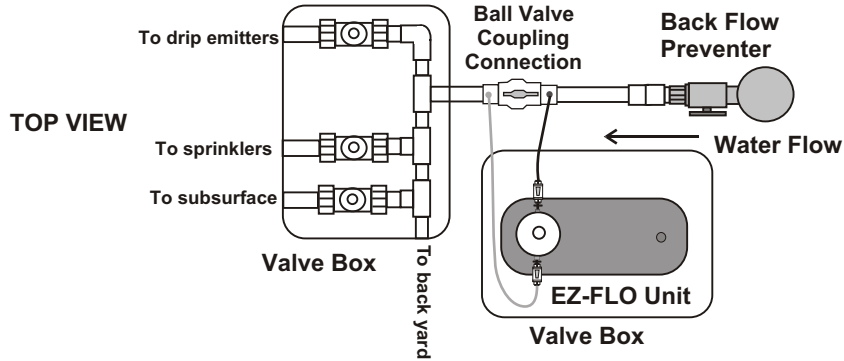

Step 1 - Locate the installation point.

Connection must be made after an approved back flow prevention device. It is preferable to have the tank cap above the installation point in the sprinkler line if possible but it is not required for efficient operation. The connection can be made either vertically or horizontally in the sprinkler main line.

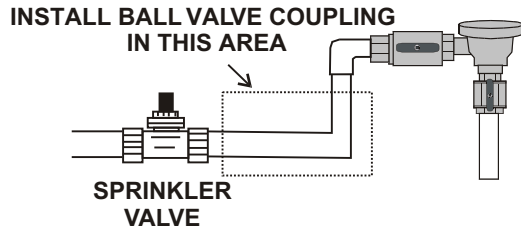

Step 2 - Shut off water by closing a valve at the back flow preventer or in the main line upstream from the connection point. Relieve the pressure from the line at the exhaust valve on the back flow preventer or by manually opening a sprinkler valve.

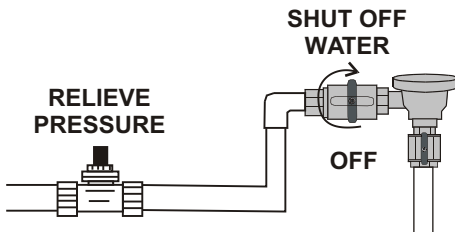

Step 3 - Cut out a section of pipe slightly larger than the cut out length of the ball valve coupling. Determine the length of the cutout by measuring the length from socket to socket inside the ball valve coupling. If the space for the coupling is cut too large it may prevent the pipe and the coupling from forming a solid seal. (Unions may be used for easier retrofit installations.)

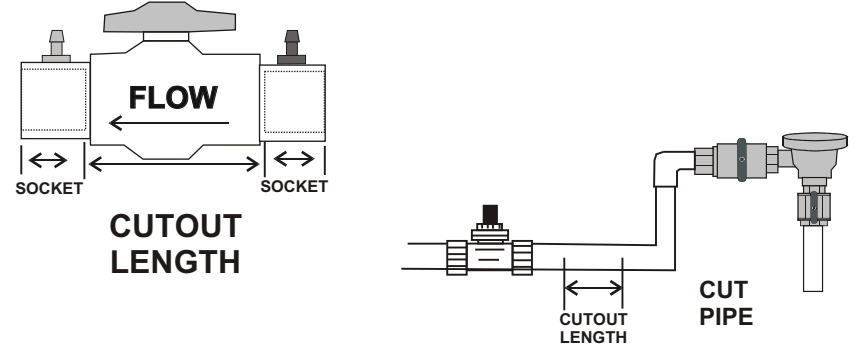

Step 4 - Glue the ball valve coupling into the line. The pipe should fit into both ends of the ball valve coupling and seat against the ball valve coupling socket. Be sure that the blue fitting is closer to the back flow preventer than the green fitting and that the flow direction of the water matches the flow direction arrow on the side of the ball valve coupling.

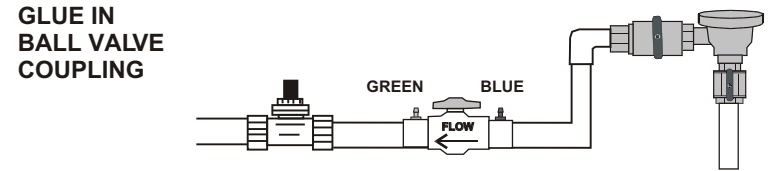

Step 5 - Attach tubing to the ball valve coupling. Press the black tube over the blue fitting on the ball valve coupling. Press the clear tube over the green fitting on the ball valve coupling. Put tubing clamps over the tubing below the barbed end of the fitting and squeeze them until they are tightly secured.

